

1948 Cadillac Series 62 Club Coupe

RW25004

Assembly instruction



redwheelmodels.com

 **RED
WHEEL**

Colors

A - body color

B - semi-gloss black

C - chrome

D - grey

E - aluminium

F - steel

G - beige

H - interior color 1

I - interior color 2

J - interior color 3

K - interior color 4

L - carpet color

M - clear red

N - green













O - white

P - red

Tips

- The colors in the instruction are for example.
For correct painting, use pictures of an original car
- Cut 3D printed parts with a sharp blade
- Do a dry-fit before painting
- Wash resin parts with soapy water before painting
- Use any type of CA glue

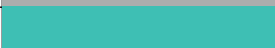
Factory body colors

NAME	MATCHING COLORS (DUPONT)	ORIGINAL COLOR No.	SAMPLE
Black	246-2048	253-2228 20498-A	
Amherst Blue	431	P.S.2251	
Cavern Green	476	023355	
Tyrolian Gray	676	P.S.1195	
Cypress Green	674-6	G.S.333	
El Paso Beige	549	P.S.8851	
Horizon Blue	678	022293D	
Kingswood Gray	675	P.S.1194	
Madeira Maroon	146-M	P.S.633	
French Gray	668	020152	
Lucerne Green	238-G	260-39302	
Belden Blue	517	P.S.219	

Resin parts

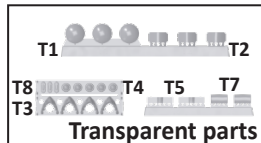
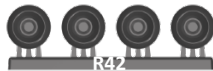
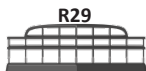
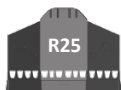
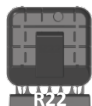
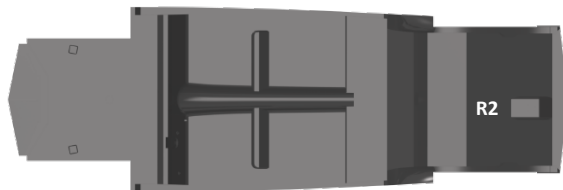
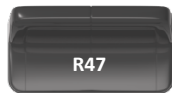
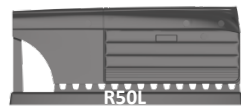
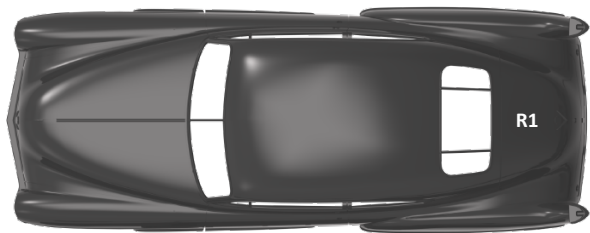

3D printed parts

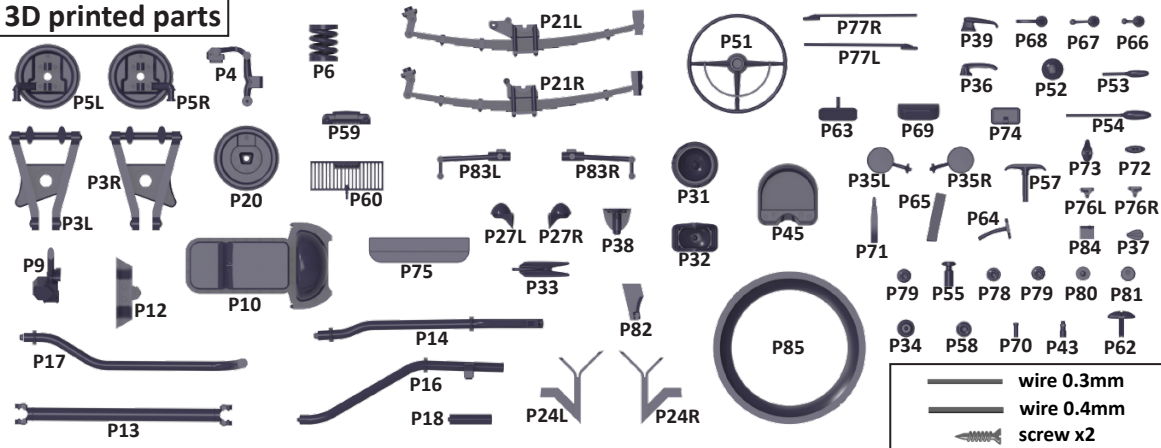

PE

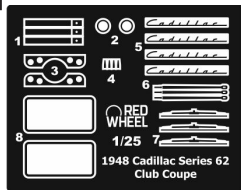

Decal



Windows

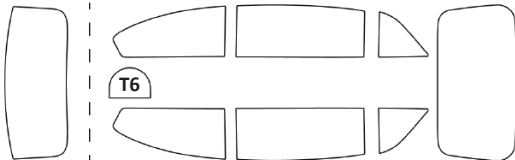

1.Chassis Front End

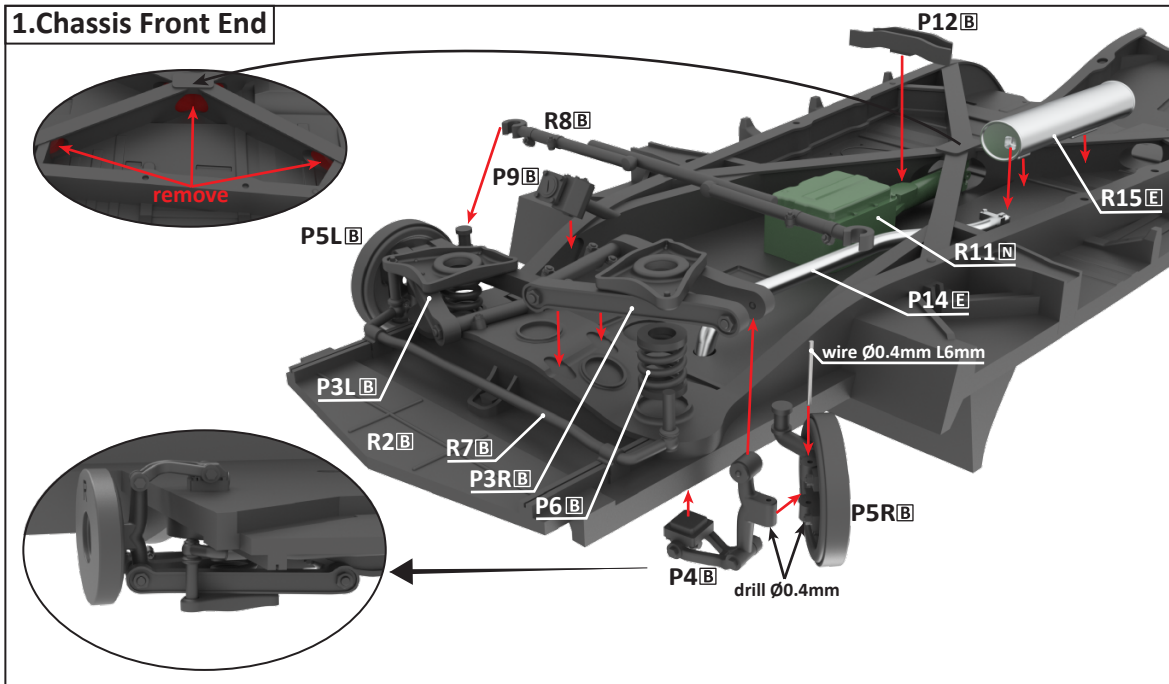

2.Chassis Rear End

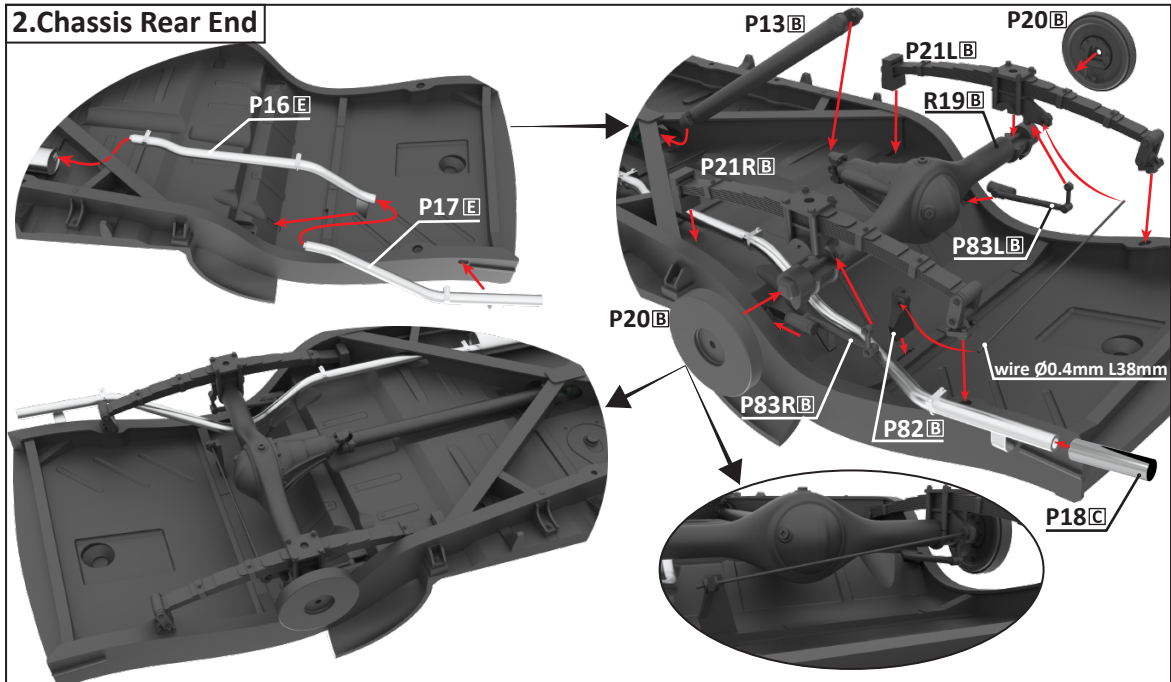

3. Dashboard

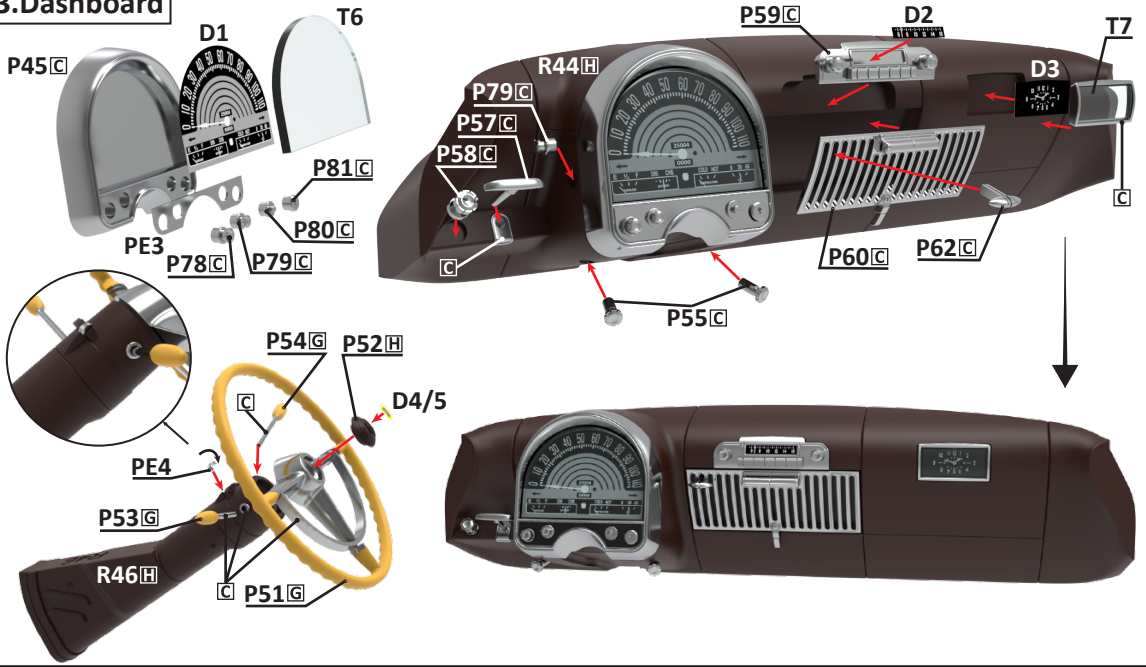

4. Door panels

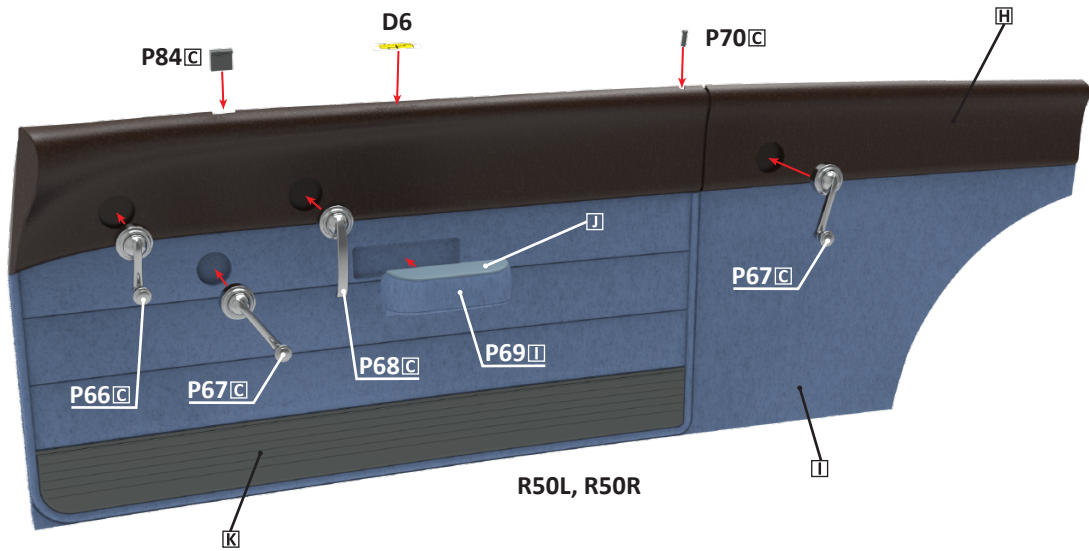

5. Interior

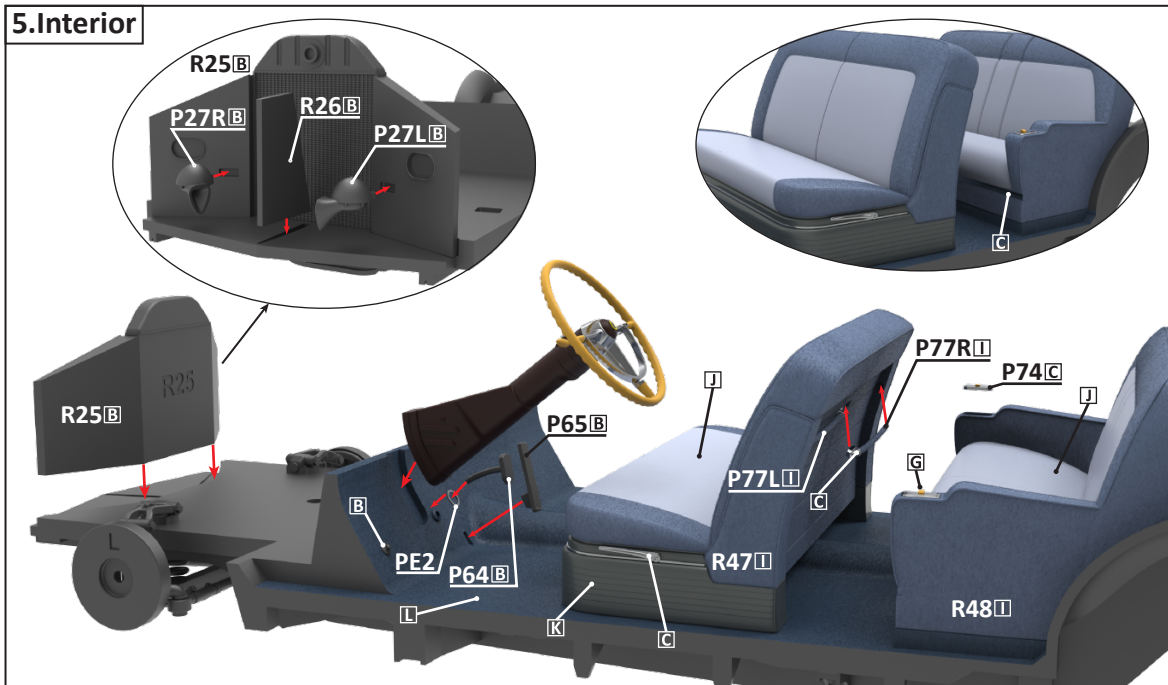

6.Body

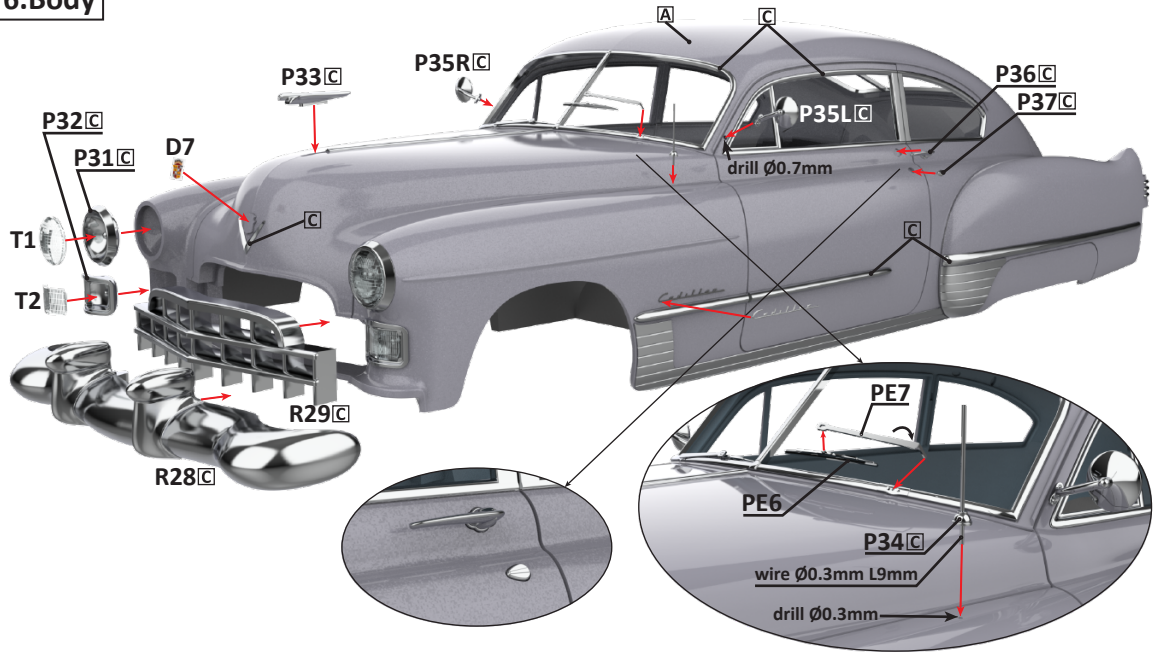

7. Body Rear End

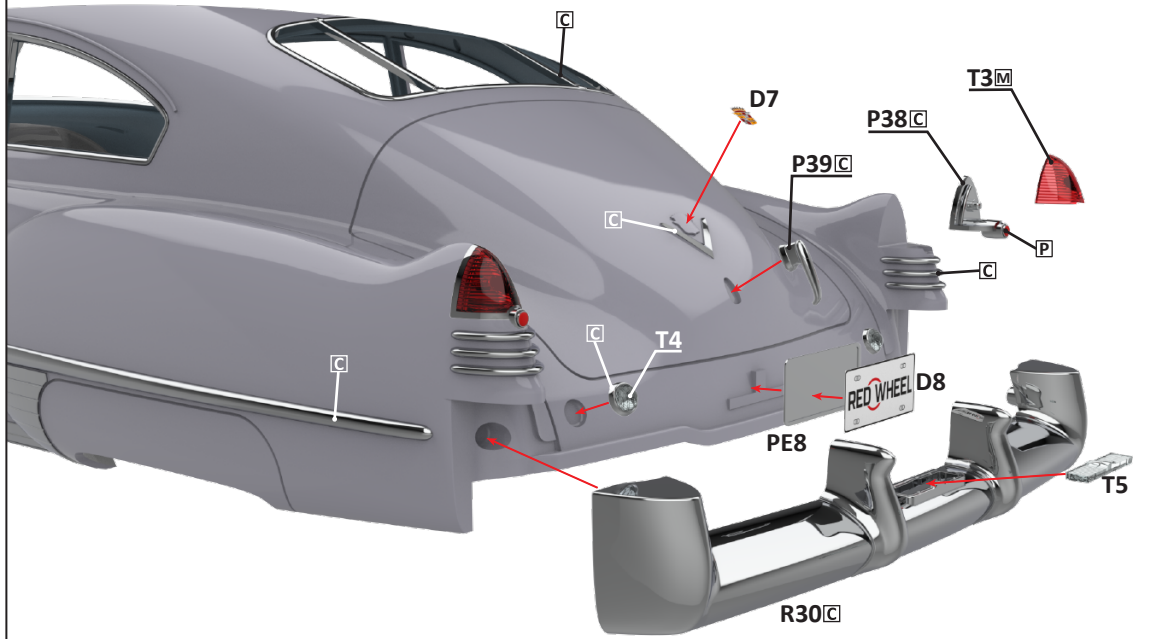

8.Body inside

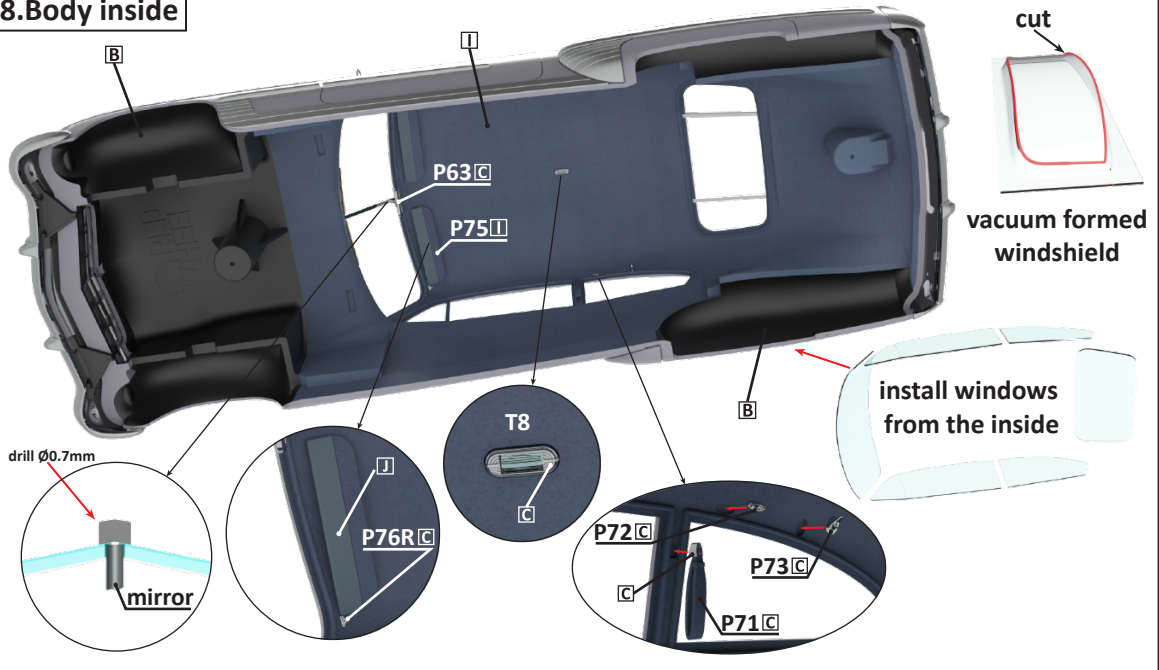

9. Final assembly

